

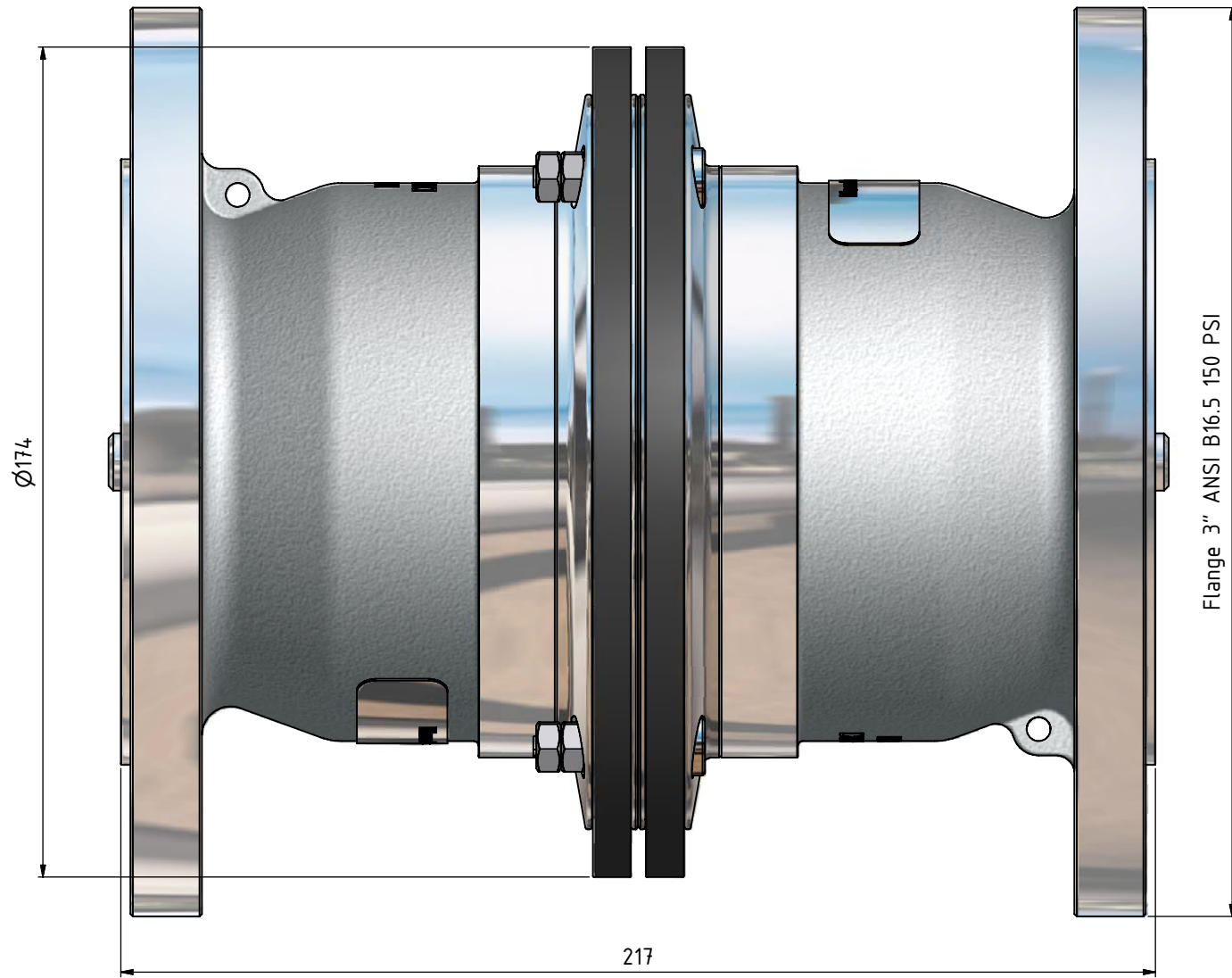

Notice: This drawing contains proprietary information and shall not be used or reproduced or its contents disclosed in whole or in part, without the prior written consent of the Mann Technik AB



Dimensions are in metric.

Weight: 5,5 kg

Detail No:	Material	Ämne/Blank	Ytbeh./Treatment	Vikt/Weight
	Designed/drawn by P. Nyberg	Scale: 1:1	Dimension with no tolerances acc to Machined SS-ISO 2768-1 medium Weld Forge SS-ISO 2768-1 coarse Surface roughness ISO 1302 Form & position tol SS ISO 1101	
	Checked G. Kopplin	Date 2009-10-20		
	Approved T. Mann			
<b>Industrial Break-Away 3"</b> <b>Flange 3" ANSI 150 PSI</b>			Data nr./Comp No. N461D1101	Blad/Sheet 1 / 1
			Drawing No. N461D1101-1	Rev.

NO.	Revision comprises	Date	Sign.	Appr by
-----	--------------------	------	-------	---------